

**G:B:D:**

**◉ ACCESSORIES**





# DOMINO



# DOMINO

Dominates any type of system with the ease of a simple gesture that touches an object of high design. DOMINO is reliable and user-friendly with its ergonomic small (but not too small) buttons. You can attach it to your key ring or secure it in your car using the fastening system included in the blister pack.

With the nifty accessories you can personalise your remote control in your favourite colour, in fact, the covers are easily interchangeable in just a few seconds.

DOMINO: the modern way of using the most advanced safety devices



# MANAGER

## Remote controls - Frequency 433 MHz



### DTC 4334

Rolling Code remote control, two-colour black-grey, 4 channels, frequency 433 MHz, with key ring and Velcro fastening included. It can work only with the MANAGER system

Package Pieces 1  
Code AU03010



### DTC 4334

Rolling Code remote control, two-colour black-grey, 4 channels, frequency 433 MHz. It can work only with the MANAGER system

Package Pieces 40  
Code AU0410



### BLISTER ACCESSORY

Set of 3 coloured covers for DTC 4334 + key ring and Velcro fastening

Package Pieces 1  
Code AU04000

## Radio receivers - Frequency 433 MHz



### DRC 4334

4-channel receiver for DRR 1000, DRR 2000 cases and DSL 2000 flashing light (outdoor use). It can work only with the MANAGER system

Package Pieces 1  
Code AU02820



### DRC 4334

2-channel plug-in receiver for control units. It can work only with the MANAGER system

Package Pieces 1  
Code AU02920

## Programmer



### MANAGER

Programmer that allows the complete management of all the installations made with the MANAGER series devices

Package Pieces 1  
Code AS05150

## Accessories



### DCT 100

TRANSPONDER (Rolling Code) transmission device in packets of 20 pcs., without plastic case, to insert into DOMINO remote control. It can work only with the MANAGER system

Package Pieces 20  
Code AU03040



### DCT 200

TRANSPONDER (Rolling Code) transmission device in packets of 20 pcs., in plastic case. It can work only with the MANAGER system

Package Pieces 20  
Code AU03030



### DCT 300

TRANSPONDER (Fixed Code) transmission device in packets of 20 pcs., in plastic case. It can work only with the MANAGER system

Package Pieces 20  
Code AU03035



### DCT 400

TRANSPONDER (Fixed Code) CARD transmission device in packets of 20 pcs. It can work only with the MANAGER system

Package Pieces 20  
Code AU03070

€ 110,00



### DCX 100

TRANSPONDER receiver for DCT 100 and DCT 200. Frequency 433 MHz. Activation distance 0+20 mm. It can work only with MANAGER system (12/24 Vdc - ac)

Package Pieces 1  
Code AU05000



### DCD 100

Keyboard for the activation up to 9 installations dialling up to 1000 customized codes. Frequency 433 MHz. It can work only with the MANAGER system (12/24 Vdc - ac or battery)

Package Pieces 1  
Code AU02100

# MANAGER

## MANAGER System

The programmer easy to use that allows the complete management of all the installations made with MANAGER series devices.

The possibility to manage the system by PC makes it easy to use and flexible.

The solution offered by GIBIDI to all customers who want to make the installation their own domain.

The system programming is done in WIRELESS technology.

MANAGER allows the user to program transmitting and receiving devices both at radio frequency and at transponder and to manage functionality, customization, authorisation, modification and also the innovatory system anti-cloning always in safety modality (ROLLING-CODE).

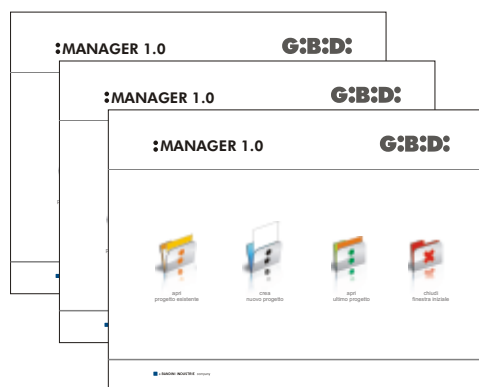



# PRG

## Remote controls - Frequency 433 MHz



**DTS 4334**  
Rolling Code remote control,  
black, 4 channels,  
frequency 433 MHz,  
with key ring and  
Velcro fastening included

Package Pieces 1  
Code **AU03000**



**DTS 4334**  
Rolling Code remote control,  
black, 4 channels,  
frequency 433 MHz

Package Pieces 40  
Code **AU0400**



**BLISTER ACCESSORY**  
Set of 3 coloured covers  
for DTS 4334 + key ring  
and Velcro fastening

Package Pieces 1  
Code **AU04000**

## Radio receivers - Frequency 433 MHz



**DRS 4334**  
4-channel receiver  
for DRR 1000 case  
and DSL 2000 flashlight  
(outdoor use)

Package Pieces 1  
Code **AU02810**



**DRS 4332**  
2-channel plug-in receiver  
for control units

Package Pieces 1  
Code **AU02910**

## Programmer



**PRG 01**  
Programmer to customize  
remote controls and receivers,  
copy memories, add and/or  
remove users and other  
advanced functions

Package Pieces 1  
Code **AS05140**

# PRG

## PRG System

The base programmer that allows the user to program the ROLLING-CODE transmitters and

receivers with customized code, add, display and erase users with UP & DOWN search.





# DSL



**DSL2000**  
Plastic flashlight covers  
AU02700



**DSL230A**  
230 Vac fixed-light board  
+ bulb  
AU02710



**DSL230B**  
230 Vac intermittent-light board  
+ bulb  
AU02720



**DSL024A**  
24 Vdc fixed-light board  
+ bulb  
AU02724



**DSL012A**  
12 Vdc fixed-light board  
+ bulb  
AU02712



**DSL230L**  
Control unit LED 230 Vac  
AU02610



**DSL024L**  
Control unit LED 24 Vdc  
AU02624

## Accessories



**AU02810**  
4-channel 433 MHz  
radio receiver



**AU02820**  
4-channel 433 MHz radio  
receiver. It can work only  
with the MANAGER system



**70187**  
Antenna with cable 4 m  
Frequency 433 MHz

**CAUTION: DSL2000 does not include the light board + bulb, which must be ordered separately**

## Installation example



wall-mounted



rotating base



pillar-mounted



# DSL

**System  
for external  
flashlight**

Yet another joy of modern technology and intelligent design applied to a flashlight. Thanks to its modularity and extremely easy installation, the radio receiver and antenna are quickly integrated into one single product. All you have to do is choose the type of flashlight and your product is complete.

If you decide to use the built-in radio receiver, you can store the transmitters simply by using the controls on the case. DSL: the new hallmark of your automatic gate.

Kit contents



# ● DRR

## Accessories



**DRR1000**  
Outdoor case for  
4-channel receiver  
**AU02800**



**DRR2000**  
Outdoor case for receiver  
**AU02600**



**AU02810**  
4-channel 433 MHz  
radio receiver



**AU02820**  
4-channel 433 MHz radio  
receiver. It can work only  
with the MANAGER system



**70187**  
Antenna with cable 4 m  
Frequency 433 MHz

## Installation example



wall-mounted



rotating base



pillar-mounted

# DRR

**Outdoor  
case for  
radio receiver**

A new case for radio receivers suitable for outdoor installation.

Thanks to the extreme modularity, it can be wall-mounted or pillar-mounted.

The kit includes an adapter to install the outdoor antenna directly on the case.

A new design for a simple and functional product.

Kit contents

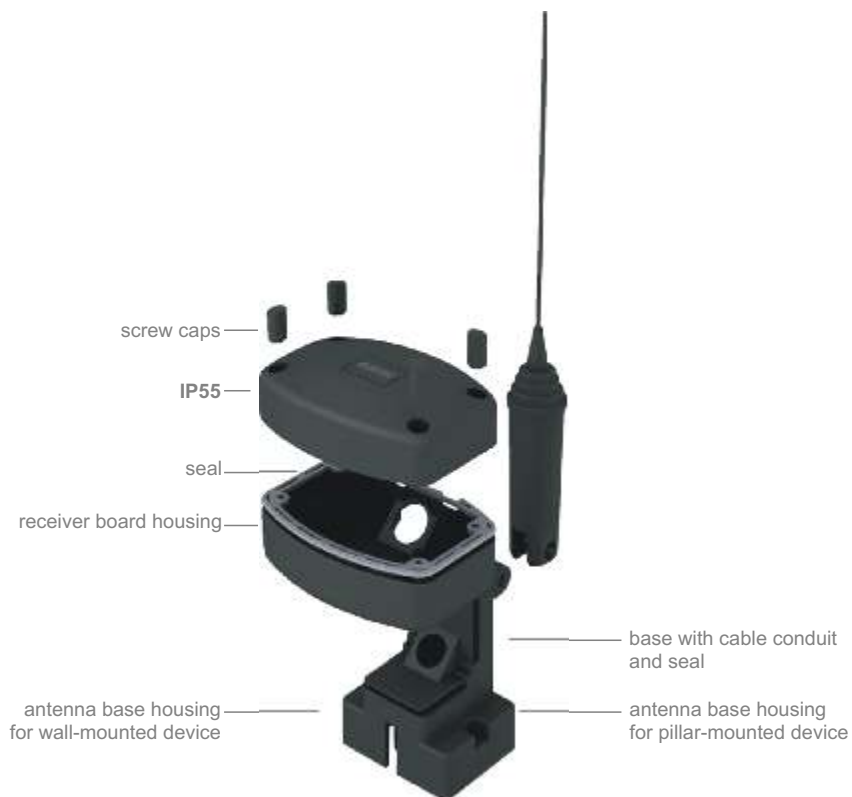





# DC



		Package Pieces	Code
<b>DCF180</b>	Pair of synchronised photocells, 180° rotation (12/24 Vdc/Vac), maximum range 30 m • IP54	1	<b>AU02000</b>
<b>DCF180D</b>	Pair of synchronised digital photocells (maximum 16 pairs), 180° rotation (12/24 Vdc/Vac), maximum range 30 m • IP54	1	<b>AU02010</b>
<b>DCF180DB</b>	Pair of synchronised digital photocells, 180° rotation (12/24 Vdc/Vac) with battery-powered transmitter (batteries included), maximum range 20 m • IP54	1	<b>AU02020</b>
<b>DCB100</b>	Spare battery kit for DCF180DB (AU02020)	1	<b>AU01990</b>



		Package Pieces	Code
<b>DCS100</b>	 Wall-mounted key selector and DCA series columns + 3 keys • IP54	1	<b>AU01940</b>
<b>DCS200</b>	 Wall-mounted key selector and DCA series columns with LED light + 3 keys • IP54	1	<b>AU01950</b>
<b>DCS300</b>	 Wall-mounted key selector battery-powered via radio and DCA series columns + 3 keys • IP54	1	<b>AU01960</b>

 The key selectors **must be ordered asking for the specific code**. The following 10 encoding codes are available:  
01 - 02 - 03 - 04 - 05 - 06 - 07 - 08 - 09 - 10

To order a selector with relative key encoding code you need to indicate the product code followed by the encoding code.

Example: **DCS100** with encoding code **03** - order **AU01940/03**

**For more information on encoding see page 5**

# DC

**Posts**  
**Photocells**  
**Selectors**  
**Lights**

The new range of GIBIDI accessories, posts, photocells and wall-mounted key selectors. A range designed to be adaptable to any kind of installation or aesthetic requirement, a patented system that includes technology, design

and easy installation. A modular system that allows easy setting up and maintenance. The perfect solution to complete your automatic entrance

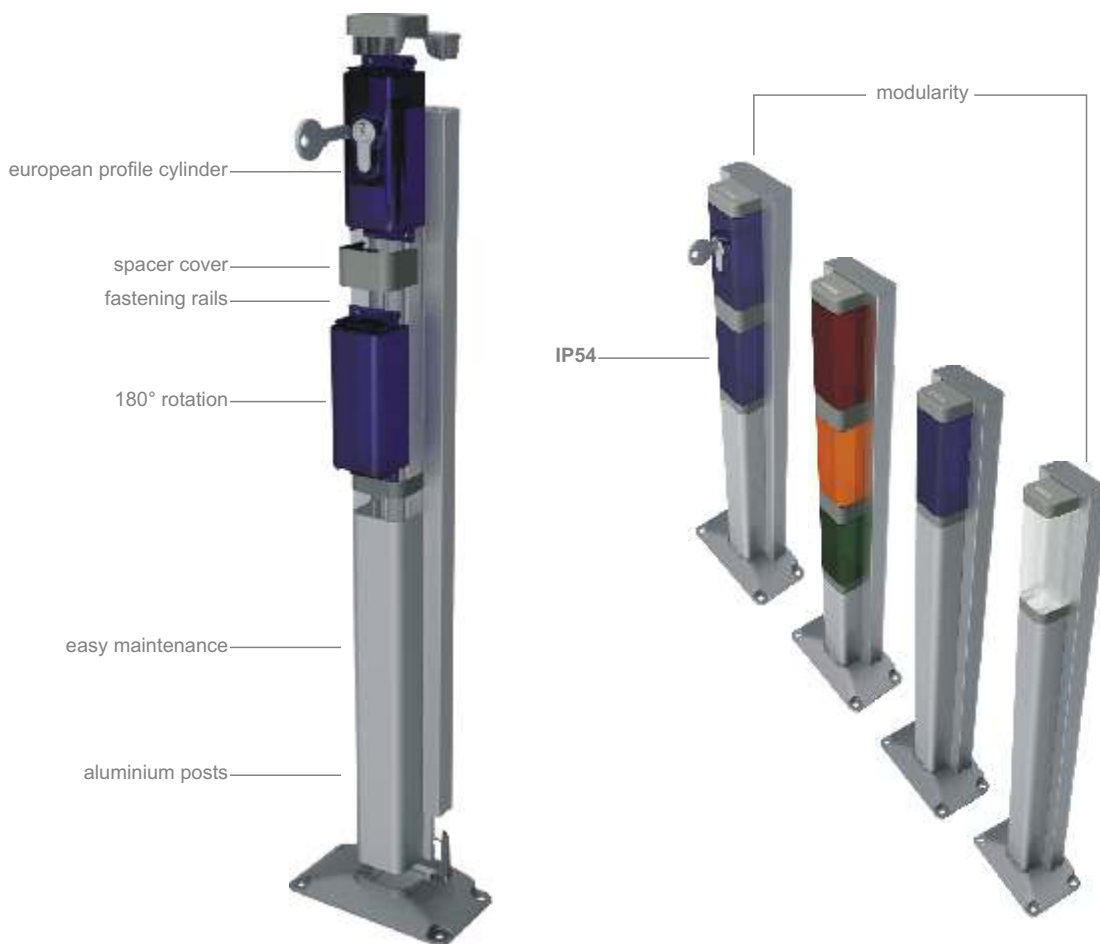

# DC



			Code
<b>DCX100</b>	TRANSPONDER receiver for DCT 100 and DCT 200. Frequency 433 MHz (12/24 Vdc - ac) Enabling distance 0÷20 mm. It can work only with the MANAGER System • IP54	1	<b>AU05000</b>



		Package Pieces	Code
<b>DCT100</b>	TRANSPONDER transmission device (Rolling Code) in packets of 20 pcs., without plastic cases, to insert into the DOMINO transmitter. It can work only with the MANAGER system	20	<b>AU03040</b>



<b>DCT200</b>	TRANSPONDER transmission device (Rolling Code) in packets of 20 pcs., in plastic cases. It can work only with the MANAGER system	20	<b>AU03030</b>
---------------	--	----	----------------



<b>DCT300</b>	TRANSPONDER transmission device (Fixed Code) in packets of 20 pcs., in plastic cases. It can work only with the MANAGER system	20	<b>AU03035</b>
---------------	--	----	----------------



<b>DCT400</b>	TRANSPONDER (Fixed Code) CARD transmission device in packets of 20 pcs. It can work only with the MANAGER system	20	<b>AU03070</b>
---------------	---	----	----------------



		Package Pieces	Code
<b>DCD100</b>	Keyboard for the activation up to 9 installations dialling up to 1000 customized codes. Frequency 433 MHz (12/24 Vdc - ac or battery) It can work only with the MANAGER system • IP54	1	<b>AU02100</b>
<b>DCB200</b>	Battery kit for DCD100 (AU02100)	1	<b>AU01995</b>

# DC



<b>DCL100</b>	Yellow LED light 24 Vdc/Vac • IP54 (usable as flashlight)
Package Pcs.	Code
1	<b>AU02050</b>



<b>DCL200</b>	Red LED light 24 Vdc/Vac • IP54
Package Pcs.	Code
1	<b>AU02060</b>



<b>DCL300</b>	Green LED light 24 Vdc/Vac • IP54
Package Pcs.	Code
1	<b>AU02070</b>



<b>DCL400</b>	LED courtesy light 24 Vdc/Vac • IP54
Package Pcs.	Code
1	<b>AU02090</b>



<b>DCA110-1</b>	<b>A</b> Aluminium posts H = 110 cm for one DCF photocell, DCS selector or DCL lights	Package Pcs.	Code
		2	<b>70400</b>
<b>DCA110-2</b>	<b>B</b> Aluminium posts H = 110 cm for two DCF photocells, DCS selector or DCL lights	Package Pcs.	Code
		2	<b>70410</b>
<b>DCA055-1</b>	<b>C</b> Aluminium posts H = 55 cm for one DCF photocell, DCL lights	Package Pcs.	Code
		2	<b>70420</b>

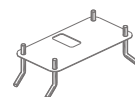

<b>DCA200</b>	Foundation plate for DCA and DGA columns
Package Pcs.	Code
2	<b>AU01980</b>



<b>DCA100</b>	Plastic spacer cover to integrate 2 photocells and a selector or to create a traffic light
Package Pcs.	Code
4	<b>AU01970</b>



# • DG



**DGF100** Pair of 60 Ø built-in photocells (12/24 VDC/VAC), maximum range 30 m • IP54

Package Pcs.	Code
1	<b>AU01900</b>



**DGF200** Pair of wall-mounted photocells (12/24 VDC/VAC), maximum range 30 m • IP54

Package Pcs.	Code
1	<b>AU01910</b>



**DGS100**  60 Ø built-in key selector with European Profile cylinder + 3 keys IP54

Package Pcs.	Code
1	<b>AU01920</b>



**DGS200**  Wall-mounted key selector with European Profile cylinder + 3 keys IP54

Package Pcs.	Code
1	<b>AU01930</b>



**DGA110-1**  Aluminium posts H = 110 cm for one DGF photocell, DGS selector

Package Pcs.	Code
2	<b>70300</b>

**DGA110-2**  Aluminium posts H = 110 cm for two DGF photocells, DGS selector

2	<b>70310</b>
---	--------------

**DGA055-1**  Aluminium posts H = 55 cm for one DGF photocell

2	<b>70320</b>
---	--------------



Plastic case to be built in for DGS100 and DGF100

Package Pcs.	Code
1	<b>A90777P</b>



Galvanised case to be built in or welded for DGS100 and DGF100

Package Pcs.	Code
1	<b>70176</b>

# • DG

**Posts**  
**Photocells**  
**Selectors**

The range of GIBIDI accessories, posts, photocells and built-in or wall-mounted selectors.

A range that can be adapted to any kind of installation requirement, that includes technology and ease of installation.

A modular system that allows easy setting up and maintenance.

Another solution to complete your automatic entrance.





# DS

## 8K2 conductive edges



<b>DSG40</b>	Conductive rubber edge H=40 in rolls of 12 m
Package Pcs.	Code
1	<b>70600</b>



<b>DSA200</b>	Aluminium strip for conductive edge L=2 m
Package Pcs.	Code
6	<b>70620</b>



<b>DSK40</b>	Kit to make up 6 frames H=40. The kit is composed of 6 connectors with 8K2 resistor, 6 connectors with 3 m cable 3 m, 6 caps, 1 bottle of glue, 1 bottle of primer
Package Pcs.	Code
1	<b>70660</b>



<b>DSC70</b>	Control board for 8K2 edges IP55
Package Pcs.	Code
1	<b>AS05070</b>



<b>DSF150</b>	Conductive edge with complete 8K2 resistor H=40 - L= 1.5 m
Package Pcs.	Code
1	<b>70630</b>



<b>DSF180</b>	Conductive edge with complete 8K2 resistor H=40 - L= 1.8 m
Package Pcs.	Code
1	<b>70640</b>



<b>DSF200</b>	Conductive edge with complete 8K2 resistor H=40 - L= 2 m
Package Pcs.	Code
1	<b>70650</b>



<b>DSC80</b>	Control board for 8K2 edges, EN 12978 certified • IP55
Package Pcs.	Code
1	<b>AS05080</b>

DS

## mechanical rubber edges



---

**DSM150** Mechanical rubber frame with  
aluminium rail - L=1.5 m

Package Pcs.	Code
1	<b>70212</b>



---

**DSM170** Mechanical rubber frame with  
aluminium rail - L=1.7 m

Package Pcs.	Code
1	<b>70192</b>



---

**DSM200** Mechanical rubber frame with  
aluminium rail - L=2 m

Package Pcs.	Code
1	<b>70193</b>

 a **BANDINI INDUSTRIE** company



Associated

---



# GIBIDI

**GI.BI.DI. S.r.l.**

Via Abetone Brennero, 177/B  
46025 Poggio Rusco (MN) - ITALY  
Tel. +39.0386.52.20.11  
Fax +39.0386.52.20.31  
info@gibidi.com

[www.gibidi.com](http://www.gibidi.com)