

BGI Flap Barrier FP : 40 / FP : 120



Single barrier panel

Dual barrier panel

Cabinet style / Barrier type	rounded fronts / low-height	
Available models	single barrier panel / dual barrier panel	
Dimensions	Cabinet height	1040 mm
	Cabinet length	1000 mm
	Cabinet width	200 mm
	Barrier height	900 mm
	Passage width	single panel: 550 mm max. (550 mm standard) dual panel: 920 mm max. (650 mm standard)
ADA compliant / Wheelchair	dual panel version only	
Standard material	Base and housing	brushed stainless steel (SS 304)
	Tops / Lids	brushed stainless steel (SS 304)
	Barrier types	glass barrier panels (10mm tempered)
Power supply (dual barrier panel)	AC100-220V-50/60Hz	
Communication interface	RS-485/ USB/ Ethernet	
Safety & security detection elements	Number of IR sensor pairs (Transmitter / Receiver)	6
	Tailgating and crawl under detection	yes
	Climb over detection	yes - electronic detection
Fire / Emergency mode (dedicated input)	released (manually open) or drive open automatically (with optional battery back-up)	
Operating environment	indoor/outdoor covered	
Optional accessories	Access Light with integrated proximity reader bracket	yes
	Lane Light	no
	Remote control	yes (Touch Panel or TMON SW application for PC)
	Power supply back-up	yes
	Ramp LT (mounting bases)	yes
	Alternative material	yes (see specification overview)

For more additional options see Specification overview

BGI Flap Barrier FP : 40 / FP : 120 - single barrier panel



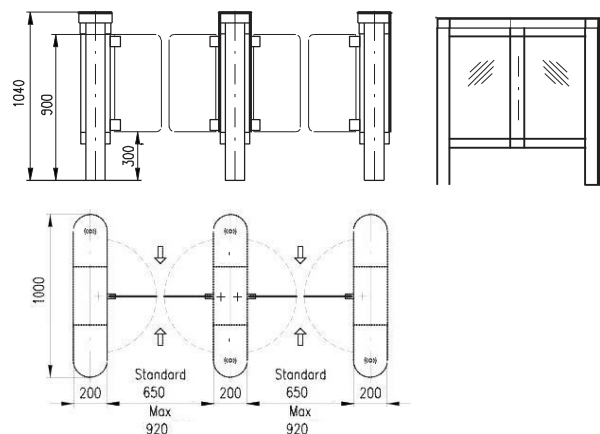
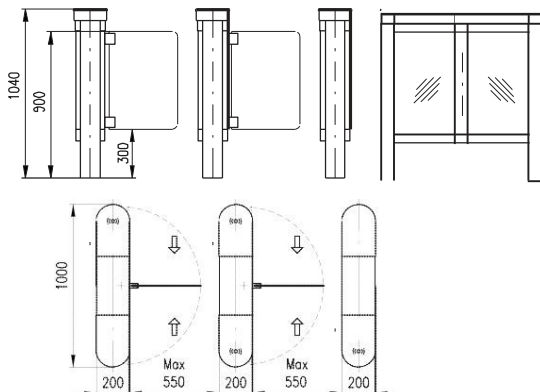





BGI Flap Barrier FP : 40 / FP : 120 - dual barrier panel





BGI ENGITECH PVT LTD

Affordable and Impregnable security from Israel

Picture	Type	Description
BGI FP : 40 Flap Barrier		
	Flap Barrier FP : 40 Side cabinet	Side cabinet with glass panels on one side Glass panels - toughened safety glass 8mm glass, transparent, height - 940mm Surface finish - Brushed stainless steel, Middle cover - Brushed stainless steel <i>13,8VDC Fail-Safe motor drive unit</i> Traffic Light/Access light information panels NOT INCLUDED Power supply unit not included (internal power supply unit SM-12 is obligatory!!)
	Flap Barrier FP : 40 Middle cabinet	Middle cabinet with glass panels on both sides Glass panels - toughened safety glass 8mm glass, transparent, height - 940mm Surface finish - Brushed stainless steel, Middle cover - Brushed stainless steel <i>13,8VDC Fail-Safe motor drive unit</i> Traffic Light/Access light information panels NOT INCLUDED Power supply unit not included (internal power supply unit SM-12 is obligatory!!)
	Flap Barrier FP : 40 Side cabinet - Wide	Side cabinet with one wide half-size glass panel for wheelchair access lane Glass panels - toughened safety glass 8mm glass, transparent, height - 940mm Surface finish - Brushed stainless steel, Middle cover - Brushed stainless steel <i>13,8VDC Fail-Safe motor drive unit</i> Traffic Light/Access light information panels NOT INCLUDED Power supply unit not included (internal power supply unit SM-12 is obligatory!!)
	Flap Barrier FP : 40 Middle cabinet - Wide	Middle cabinet with 1x wide glass panel for wheelchair access lane Glass panels - toughened safety glass 8mm glass, transparent, height - 940mm Surface finish - Brushed stainless steel, Middle cover - Brushed stainless steel <i>13,8VDC Fail-Safe motor drive unit</i> Traffic Light/Access light information panels NOT INCLUDED Power supply unit not included (internal power supply unit SM-12 is obligatory!!)
BGI FP : 120 Flap Barrier		
	Flap Barrier FP : 120 Side cabinet	Side cabinet with glass panels on one side Glass panels - toughened safety glass 8mm glass, transparent, height - 1200mm Surface finish - Brushed stainless steel, Middle cover - black <i>13,8VDC Fail-Safe motor drive unit</i> Traffic Light/Access light information panels NOT INCLUDED Power supply unit not included (internal power supply unit SM-12 is obligatory!!)
		1800mm high glass panel - extra charge
	Flap Barrier FP : 120 Middle cabinet	Middle cabinet with glass panels on both sides Glass panels - toughened safety glass 8mm glass, transparent, height - 1200mm Surface finish - Brushed stainless steel, Middle cover - black <i>13,8VDC Fail-Safe motor drive unit</i> Traffic Light/Access light information panels NOT INCLUDED Power supply unit not included (internal power supply unit SM-12 is obligatory!!)
		1800mm high glass panel - extra charge
	Flap Barrier FP : 120 Side cabinet - Wide	Side cabinet with one wide half-size glass panel for wheelchair access lane Glass panels - toughened safety glass 8mm glass, transparent, height - 1200mm Surface finish - Brushed stainless steel, Middle cover - black <i>13,8VDC Fail-Safe motor drive unit</i> Traffic Light/Access light information panels NOT INCLUDED Power supply unit not included (internal power supply unit SM-12 is obligatory!!)
		1800mm high glass panel - extra charge
	Flap Barrier FP : 120 Middle cabinet - Wide	Middle cabinet with 1x wide glass panel for wheelchair access lane + one narrow glass for standard lane Glass panels - toughened safety glass 8mm glass, transparent, height - 1200mm Surface finish - Brushed stainless steel, Middle cover - black <i>13,8VDC Fail-Safe motor drive unit</i> Traffic Light/Access light information panels NOT INCLUDED Power supply unit not included (internal power supply unit SM-12 is obligatory!!)
		1800mm high glass panel - extra charge